

TECHNICAL REFERENCE MANUAL

Model A36R

Absolute Bus Encoder

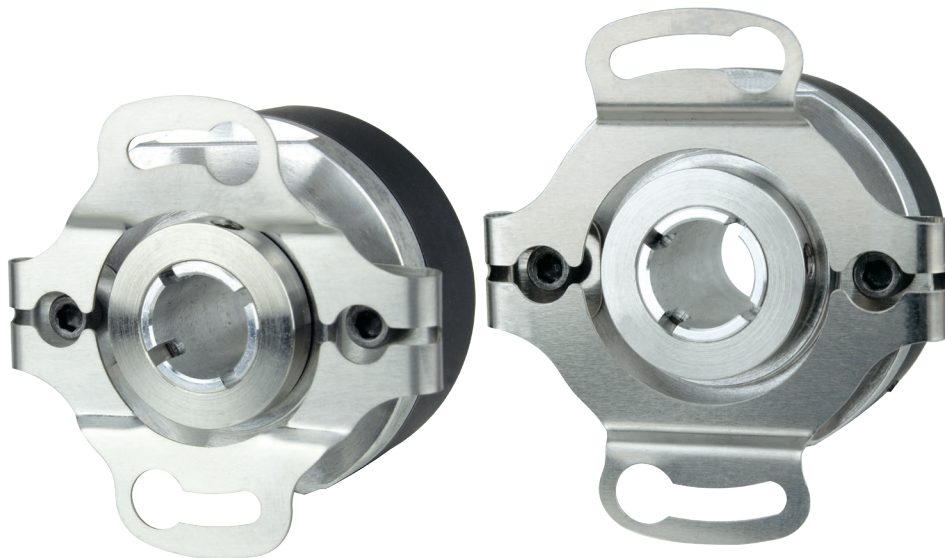

BiSS
INTERFACE

SSI
Synchronous Serial Interface

1-800-366-5412 | ENCODER.COM | SALES@ENCODER.COM

©2023 Encoder Products Company. All rights reserved.

Encoder Products Company

464276 Highway 95 South
Sagle, Idaho 83860
USA

Phone: (208) 263-8541

Fax: (208) 263-0541

Email (USA): support@encoder.com

Email (other countries): sales@encoder.com

Website: encoder.com

Table of Contents

- 1. Introduction 6**
 - 1.1 Encoder Types 6
 - 1.2 About This Manual 6
 - 1.3 Explanation of Symbols 7
- 2. Safety Information 7**
 - 2.1 Work Safely 7
 - 2.2 Special Handling & Disposal 7
- 3. Quick Start Guide 8**
 - 3.1 Cabling Considerations 8
- 4. A36R Configuration Options 8**
 - 4.1 Multi-Turn Options 8
 - 4.2 Low Power Circuit (XXL) Operation 8
 - 4.3 Multi-Turn Cable Options for XXL Version 10
 - 4.3.1 Low Power Option (XXL) with Embedded Battery Cable (EB) 11
 - 4.3.2 Low Power Option (XXL) with Power Ready Cable (no EB option) 11
- 5. Backup Power Installation and Replacement 12**
 - 5.1 Backup Power Installation 12
 - 5.2 Backup Power Replacement 13
- 6. Features 13**
 - 6.1 Preset Pin 13
 - 6.2 Error and Warning Monitoring 14
- 7. SSI Protocol 16**
 - 7.1 Overview 16
 - 7.2 SSI Packet Structure 17
 - 7.3 SSI Communication Timing 18
 - 7.4 Cable Length vs. Frequency 19
- 8. BiSS C Protocol 19**
 - 8.1 Overview 19
 - 8.2 BiSS C Packet Structure 20
 - 8.3 BiSS C Communication Timing 20
 - 8.4 Cable Length vs. Frequency 21
 - 8.5 A36R BiSS Register Mapping 22
 - 8.5.1 A36R General Memory Map 22
 - 8.5.2 BiSS EDS – Common Part 23
 - 8.5.3 BiSS EDS – BP3: BiSS Standard Encoder Profile 25
 - 8.5.4 Read and Write Registers 27
 - 8.6 BiSS Commands 28
 - 8.6.1 PRESET Command 29
 - 8.6.2 MEASURE Command 29
 - 8.6.3 DIAG Command 29
 - 8.6.4 TEMP_LIMIT_SET Command 29
- 9. CRC Details 29**
- 10. Model A36R Datasheet 30**

Index of Figures

Figure 1: Battery current draw vs. shaft speed in Active state 10
Figure 2: XXL option cable configurations. 11
Figure 3: SSI data stream with nERR and nWARN for condition reporting 14
Figure 4: BiSS data stream with nERR and nWARN for condition reporting 14
Figure 5: Typical SSI point-to-point connections 17
Figure 6: SSI data exchange. 17
Figure 7: SSI timing diagram 18
Figure 8: BiSS data exchange. 20
Figure 9: BiSS timing diagram 21

Index of Tables

Table 1: Battery monitor warning/error thresholds. 9
Table 2: Model A36R use cases for embedded battery cable 9
Table 3: Battery specifications for EB cable 11
Table 4: Voltage requirements for backup power interface. 12
Table 5: Model A36R error log 15
Table 6: Model A36R warning log 16
Table 7: SSI timing and performance characteristics. 18
Table 8: Cable length vs. max clock frequency (SSI). 19
Table 9: BiSS timing and performance characteristics. 21
Table 10: Cable length vs. max clock frequency (BiSS C). 21
Table 11: BiSS general memory map 22
Table 12: BiSS EDS – Common Part 24
Table 13: BiSS EDS – BP3: BiSS standard encoder profile 26
Table 14: Model A36R read register description 27
Table 15: Model A36R write/configuration register description 27
Table 16: Model A36R BiSS commands 28
Table 17: Command status register return codes 28

1. Introduction

1.1 Encoder Types

This manual applies to the following Encoder Products Company (EPC) encoders:

Encoder Types	Product Code
36 mm Blind Hollow Bore Absolute Encoder	A36RHB
36 mm Thru-Bore Absolute Encoder	A36RTB

Encoder serial number and firmware version can be found on the product label as shown below:



These values are also stored in internal memory (BiSS C only) in case encoder is inaccessible or label has been damaged. See Section 8.5.

1.2 About This Manual



This technical manual describes the different possibilities of mounting and configuring EPC Model A36R absolute encoders with BiSS C and SSI interfaces. Use it in addition to other documents published by EPC, such as datasheets, mounting instructions, catalogs, and flyers.

This manual is intended for individuals with technical knowledge in the use of sensors, automation equipment, and BiSS C and SSI interfaces. If you are inexperienced in this subject, EPC recommends you seek help from experienced personnel. EPC recommends you carefully review this manual before using the encoder, with special attention paid to the safety advice found throughout this manual.

Detailed BiSS C specific information may also be found at the BiSS Association website at: biss-interface.com

Please retain all included documents for future reference.

1.3 Explanation of Symbols

	<p>The IMPORTANT symbol is shown next to a section of text that describes a method for solving a particular problem.</p>
	<p>The WARNING symbol indicates that the adjacent instructions must be observed to ensure correct use of the device and to protect the user against hazards.</p>

2. Safety Information

2.1 Work Safely

The Model A36R absolute encoder with BiSS C or SSI interface is a sensor for angular measurement and is to be used for this purpose only. Encoder Products Company (EPC) denies any liability for damages caused by not following this manual. EPC absolute encoders are designed, manufactured, and distributed for use in non-safety relevant applications in industrial and commercial environments.

2.2 Special Handling & Disposal

	<p>This product may be shipped with a lithium metal (primary) cell. Lithium metal cells and batteries may present a risk of fire and/or explosion. NEVER short circuit, recharge or allow reverse current flow, puncture, incinerate, crush, drop, disassemble, immerse, or incorrectly install lithium metal cells or batteries. Do not expose lithium metal cells or batteries to high temperatures that are above the declared operating temperature range of this product and never above 85° C (185° F).</p>
---	---

This product **MUST** be shipped and/or disposed of or recycled in accordance with all applicable local, state, and federal laws and regulations.

For additional questions pertaining to the lithium metal batteries or for the latest safety data sheet (SDS), please visit: tadiranbat.com/technical-data/safety-data-sheets/ for the TL-5242/W battery. For further information, call 208-263-8541 and ask for the Safety Manager, or email: safety@encoder.com

3. Quick Start Guide

Encoder and cable installation instructions can be found in the quick start guide, located on the product page at encoder.com

3.1 Cabling Considerations

It is recommended that the encoder shaft and flex mount are secured prior to securing the cable. For header (RMH) units, mating the cable prior to mechanical installation may result in connector damage.

The recommended minimum bend radius for Model A36R cables is 2.0 inches. For applications where the encoder cable is static, tighter bend radii are acceptable.

Strain relief shall be no less than 2.0 inches from the encoder. For cables mating to header (RMH) units, apply strain relief to the jackets portion of the cable. Do not apply strain relief to directly to wires and avoid tight bend radii for wires.

4. A36R Configuration Options

The Model A36R is available in any combination of the following configuration options:

Shaft/Bore	Turns Counting	Protocols	Connector Types
Blind Hollow Bore	Single Turn or Multi-Turn	BiSS C or SSI	Radial Mount Header or Fixed Cable
Thru-Bore			

4.1 Multi-Turn Options

The Model A36R is available in two different multi-turn options: XXN and XXL.

The XXN version operates as a fully functional Normal multi-turn encoder, but multi-turn count will be lost during power interruptions to the encoder. This option is adequate if uninterruptible voltage can be supplied to the encoder at +VDC. See product datasheet for voltage and current requirements.

The XXL version includes a Low power circuit for battery backup of multi-turn position data. A small external battery or power source will maintain position data for many years, even in main power loss situations.

4.2 Low Power Circuit (XXL) Operation

Model A36R encoders with the XXL option use a low power circuit that continuously monitors the main voltage. If the main voltage drops below the minimum threshold, it switches to backup voltage to maintain multi-turn position data.

The low power circuit also monitors battery voltage, featuring both error and warning thresholds. A battery warning indicates that the battery should be replaced soon to avoid multi-turn data loss. A battery error is a latching condition that indicates battery voltage has dropped below the usable threshold and multi-turn position data will be lost if main voltage is lost.

Battery warning and error thresholds are fixed values and can be found in Table 1 below.

	Minimum	Typical	Maximum
Warning Threshold	3.05 V	3.15 V	3.275 V
Error Threshold	2.95 V	3.05 V	3.15 V

Table 1: Battery monitor warning/error thresholds

Battery early warnings self-clear once the voltage level returns to a level above the warning threshold. Battery errors however are latching and must be cleared using the clear command (SCLR). See Section 6.1 (manual error clear) or Section 8.6 (error clear command) if a battery error is detected.

The low power circuit has different current draw demands depending upon the state of the device. In most instances, battery current draw is nearly zero.

The various use cases are detailed in Table 2 below.

Profile	Description	Battery Connected?	Encoder Rotating?	Primary Power?	Battery Use
Disconnected*	Battery accessory cable is not attached to an encoder, e.g., sitting on a shelf waiting for deployment.	No	--	--	Extremely small Battery drain due to internal self-discharge.
Shutdown	Battery is attached to an encoder or system that is unpowered and not in motion.	Yes	No	No	Small Battery drain required to maintain static multi-turn state.
Standby	Battery is attached to an encoder or system. The system is operating under primary power.	Yes	--	Yes	Small Battery not in use but experiences small drain from circuit parasitics.
Active	Battery is attached to an encoder or system. The system has lost primary power and the encoder is still observing movement.	Yes	Yes	Yes	Moderate Battery drain is required to keep track of changing multi-turn state.

* Use case only applies to battery accessory cable (RMH encoders)

Table 2: Model A36R use cases for embedded battery cable

The battery cable is designed to meet/exceed the life of the encoder. However, certain conditions increase current draw and decrease battery life, including operating temperature and shaft movement.

Battery current demands are low while the encoder shaft is static. However, demand increases if the encoder shaft is rotating while in the Active state, defined per Table 2. Figure 1 details battery current draw at various shaft speeds. It is advised to minimize shaft rotation while in Active state to maximize battery life.



Important: $I_{BAT,avg}$ values in Figure 1 below are averages and coincide with room temperature operation and 3.6V nominal battery voltage. $I_{BAT,actual}$ changes with changes in V_{BAT} and operating temperature.

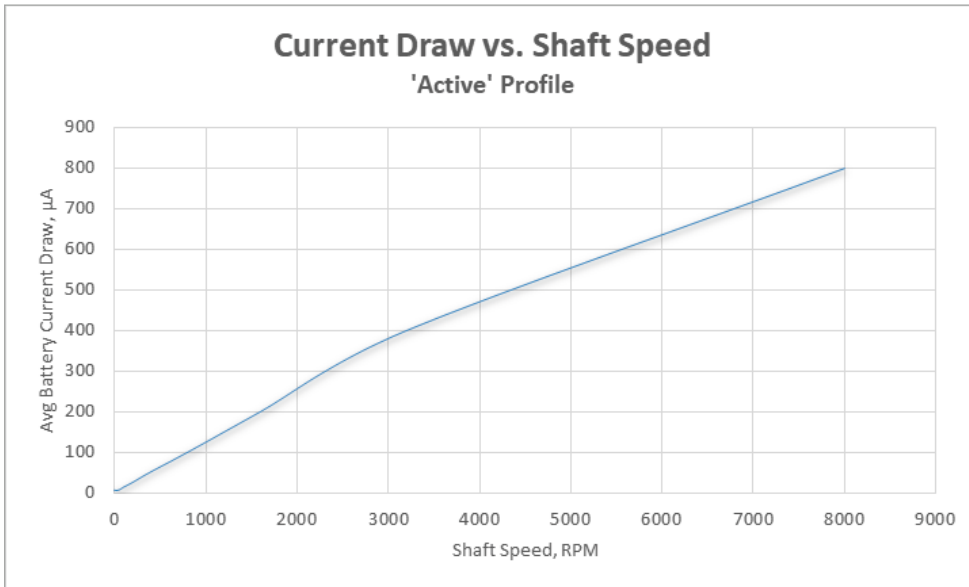

Figure 1: Battery current draw vs. shaft speed in Active state

4.3 Multi-Turn Cable Options for XXL Version

The XXL version of the Model A36R can be configured with either an embedded battery cable (EB option) or a power ready cable as shown in Figure 2 below.

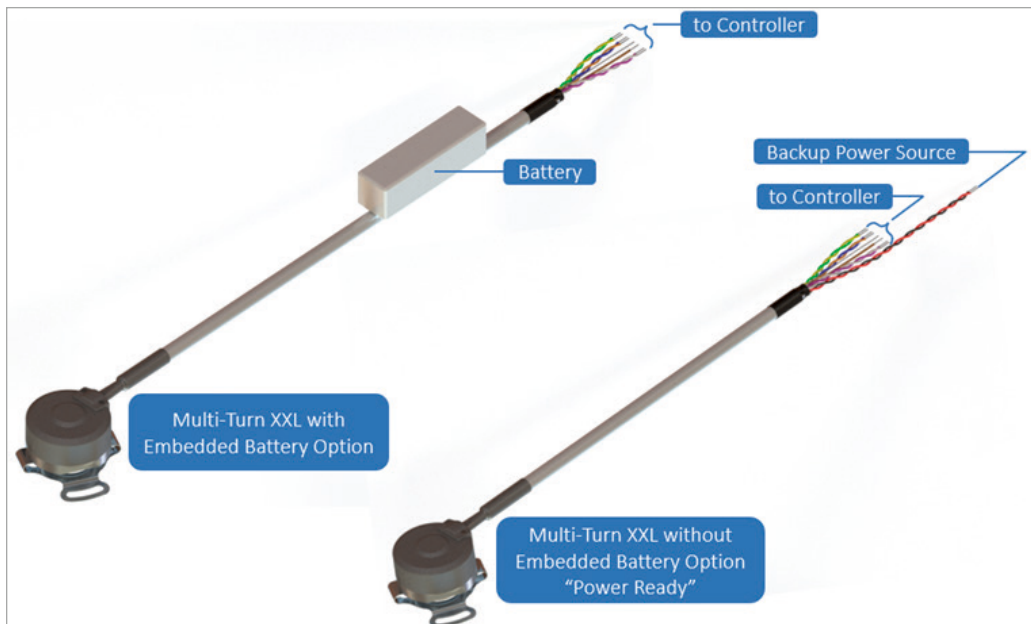

Figure 2: XXL option cable configurations

4.3.1 Low Power Option (XXL) with Embedded Battery Cable (EB)

The embedded battery cable option is ready to use upon receipt. This solution uses a Tadiran TL-5242/W battery with the following specifications:

Nominal capacity @ 1mA, to 2V	2.1 Ah
Rated voltage	3.6V
Operating temperature	-55° C to 85° C

WARNING: Min/max operating temperatures for the battery may differ from the encoder. Each component shall not exceed its respective operating temperature.

Table 3: Battery specifications for EB cable

4.3.2 Low Power Option (XXL) with Power Ready Cable (no EB option)



Important: To avoid a battery error, the battery or external power source must be connected BEFORE +VDC is applied. This applies during initial installation and backup power source replacement. See Section 5 for detailed instructions on installation of backup power source.

The battery ready cable requires an external battery or power source to be supplied at VBAT+/VBAT- to have multi-turn position data backed up during main power loss.

The electrical specifications below can be used in conjunction with Table 1 and Table 2 to select a backup power solution that will work best for your application.

V _{BAT} Min =	See Table 1
V _{BAT} Typ =	3.6V (recommended)
V _{BAT} Max =	5.5V

Table 4: Voltage requirements for backup power interface

V_{BAT} voltages below the warning/error thresholds specified in Table 1 will result in warning/error flags that will appear in the data packet. Battery error is latching and must be cleared. See Section 6.1 (manual error clear) or Section 8.6 (error clear command) for instructions if needed.

While adequate main voltage is supplied at +VDC, the encoder draws only a tiny parasitic drain from V_{BAT} (less than 10nA).

When main voltage at +VDC drops below the specified minimum, the encoder switches to low power mode and draws current from the backup power source. Current draw is relative to the encoder shaft speed. See Figure 1.

5. Backup Power Installation and Replacement

Special considerations should be taken when connecting backup power to the power ready cable. Sections 5.1 and 5.2 apply only to the power ready (standard) option. EPC does not recommend replacement of the embedded battery (EB) cable.

5.1 Backup Power Installation

When the low power option (XXL) is selected without the embedded battery option (EB), a power ready cable will be supplied. See Section 4.3 for details. For this option, you will need to install your own battery or backup power source.

When installing your own backup power source, the following steps should be taken:

- Do not apply main voltage at +VDC. If already connected, please remove.
- Apply compatible battery or backup power source. Details to aid in backup power selection can be found in Section 4.2 and Section 4.3.1.
- Connect main voltage at +VDC and power on the encoder.
- Verify no error or warning bits are present. See Section 6.2 for details.

See Section 4.2 for backup power specifications.

If the low power option (XXL) is selected with the embedded battery option (EB), the backup power source will already be installed and no installation is required.

5.2 Backup Power Replacement

If backup power does need to be replaced, please follow the steps below to avoid multi-turn position data loss:

- Leave main voltage at +VDC connected and powered on.
- Swap backup power source and ensure the new source is adequate. Details on suitable backup power sources can be found in Section 4.2 and Section 4.3.1.
- The temporary backup power loss will induce a latching battery backup error. Clear this error by issuing the clear command (SCLR). See Section 8.6.
- If unable to issue the SCLR command, perform a physical error clear by applying 0V (COM) to the Position Preset pin (PRE) for > 30 sec. See Section 6.1.

If the low power option (XXL) is selected with the embedded batter option (EB), the entire cable assembly will need to be replaced if using the radial mounted header (RMH) connector option. If a cabled version needs backup power replacement, contact EPC.

6. Features

Model A36R encoders provide user features to assist in configuration and troubleshooting. This section will detail features that are common to encoders configured with both SSI and BiSS C communication protocols. Features unique to a single communication protocol type can be found in their respective sections later in this manual.

6.1 Preset Pin

The Model A36R offers a multi-function Position Preset pin (PRE). See wiring table in the product datasheet for details.

The Position Preset pin offers two functions:

1. Defines the current shaft position as 0 ST and 0 MT
2. Issues the SCLR command to clear all errors.

To set current shaft position to 0 ST and 0 MT (preset function), the Position Preset pin should be pulled to 0V for 2-4 sec. This can be done manually or via controller I/O pin.

To issue the SCLR command, the Position Preset pin should be pulled to 0V for > 30 sec.



Warning: If manually issuing the SCLR command, ensure you have a firm connection while applying 0V to the Position Preset pin. If the connection is accidentally removed and the 0V connection duration lands in the 2-4 sec window, you will inadvertently issue the preset command and change the current encoder position.

When not being used, the Position Preset pin can be tied to 5V or left floating.



Warning: Voltage at the Position Preset pin cannot exceed 5V or permanent damage may occur.

6.2 Error and Warning Monitoring

The Model A36R features an extensive error/warning reporting mechanism. Various events are captured by the encoder and present low-active error and warning bits in the data packet for both SSI and BiSS outputs. See Figure 3 and Figure 4 below.

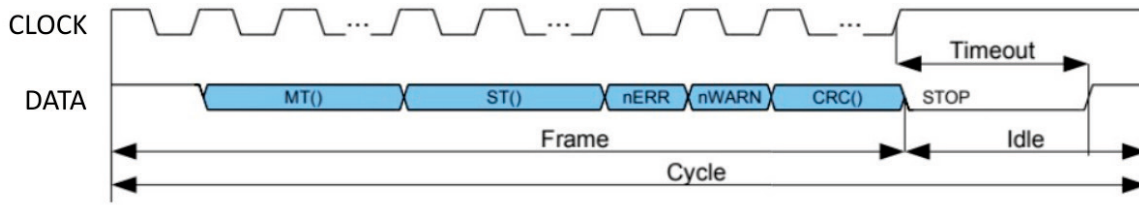

Figure 3: SSI data stream with nERR and nWARN for condition reporting

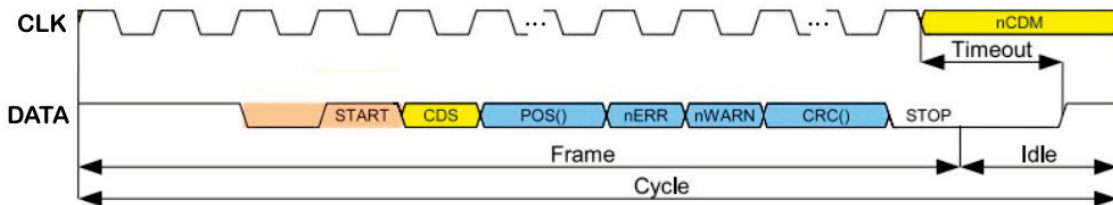

Figure 4: BiSS data stream with nERR and nWARN for condition reporting

If nERR or nWARN are activated, the error log and warning log can be read respectively to determine the cause. Details of these logs can be found in Table 5 and Table 6.



The Error and Warning Registers can only be read using BiSS C. If you observe nERR or nWARN on an SSI encoder, try the troubleshooting steps listed below, power cycle the encoder, and try manually issuing an SCLR command with the Position Preset pin as outlined in Section 6.1.

Error Log: Bank 0x44, Address 0x10			
	Bit	Condition	Solution
All Units	0	Signal error	Issue SCLR command. Power cycle device. If error persists, return to EPC for evaluation.
	1	Position error	Issue SCLR command. Power cycle device. If error persists, return to EPC for evaluation.
	2	Startup error	Issue SCLR command. Power cycle device. If error persists, return to EPC for evaluation.
	3	Internal memory error	Issue SCLR command. Power cycle device. If error persists, return to EPC for evaluation.
XXL Units Only	4	Battery error	Voltage at V_{BAT} has dropped below the error threshold (see Table 1). Ensure adequate backup voltage is applied, issue SCLR command, and power cycle if needed. Note: MT count is compromised if this error is observed.
	5	Magnet error	Magnetic disc not detected. Check for excessive runout or vibration. Issue SCLR command. Power cycle device. If error persists, return to EPC for evaluation.
Unused	6-7	n/a	These bits are unused.

Table 5: Model A36R error log

Warning Log: Bank 0x44, Address 0x11			
	Bit	Condition	Solution
All Units	0	+VDC voltage low warning	Verify +VDC is within specified range.
	1	Temp sensor not ready	Internal temperature sensor is not yet in steady state. If you are trying to read temperature or manipulate temperature limits, wait until device is ready.
	2	High temp limit exceeded	Sensor junction temperature is above specified maximum threshold. See Section 8.6 for details on setting this threshold. Temperature high limit is 140° C by default.
	3	Low temp limit exceeded	Sensor junction temperature below specified minimum threshold. See Section 8.6 for details on setting this threshold. Temperature low limit is -40° C by default.
XXL Units Only	4	Battery early warning	Voltage at V_{BAT} is below the early warning threshold (see Table 1). Replace battery soon or check that external voltage source at VBAT is set correctly.
Unused	5-7	n/a	These bits are unused.

Table 6: Model A36R warning log

Error and warning bits can be cleared by issuing the SCLR command or by power cycling. See Section 8.6 for details on issuing this command. The SCLR command may also be issued manually using the Position Preset pin. See Section 6.1 for details.

7. SSI Protocol

7.1 Overview

Synchronous Serial Interface, or SSI, is a simple serial communications protocol designed for data transfer between computers or user terminals and smart sensors.

Model A36R encoders with SSI communication are always slave devices. The fieldbus device (i.e., controller, counter) is always the master device, supplying a clock signal to which the encoder responds synchronously.



The SSI master must be configured to the correct data length and clock rate.

The master must also be configured to display the correct data type (gray or binary) supplied by the encoder. This is determined by the order code and cannot be changed.

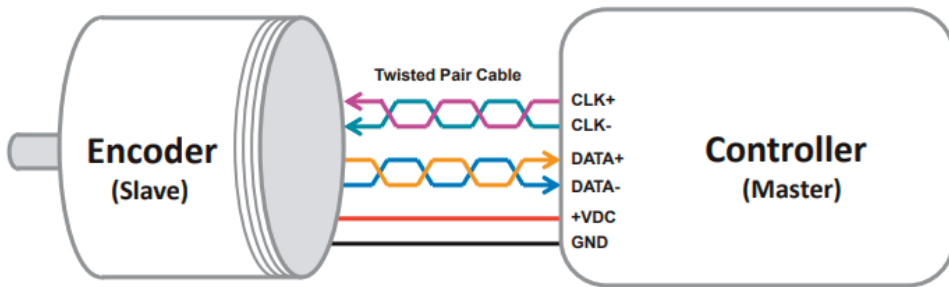

Figure 5: Typical SSI point-to-point connections

The SSI master controls the data flow from the encoder data output by sending clock pulses to the encoder clock (CLK) inputs. The encoder electronics respond to the first falling edge of the clock sequence by freezing the current position value and starting the serial output of the data bits. On every following rising clock edge from the master, one data bit is transmitted by the encoder. Additional details on timing and data structure can be found in the next section.

7.2 SSI Packet Structure

The data frame for the Model A36R with SSI protocol is shown in Figure 6 below.

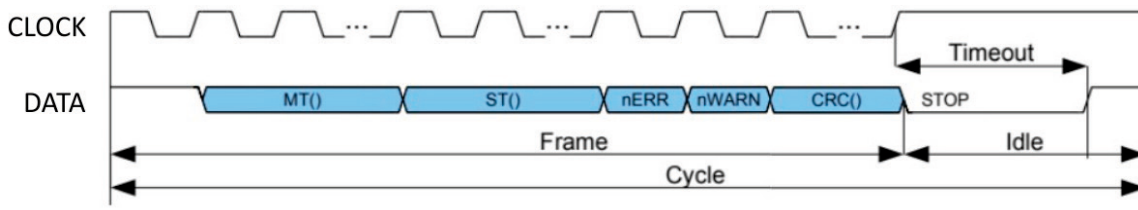

Figure 6: SSI data exchange

The data frame consists of multi-turn position data (right-aligned), single-turn position data (left-aligned), low-active err bit nERR, low-active warning bit nWARN, and a 6-bit CRC.

If the encoder was configured with no multi-turn bits, only single-turn position data will be sent.

nERR and nWARN can be monitored to provide indication of encoder errors and warnings respectively. See Section 6.2 for details. Battery early warning and battery error will trigger these bits as well for encoders configured with the low power backup (XXL) option.

The 6-bit CRC can be used to provide error checking to the critical encoder position data. Further details on CRC can be found in Section 9. A 16-bit CRC is available upon special request. Please contact EPC if this option is required.



If only position data is needed, it is possible to send only the number of clock cycles matching the position bit length (MT + ST bits) to disregard the nERR/nWARN and CRC bits at the end of the packet.

An optional 6-bit life cycle counter is also available upon special request. Please contact EPC if this option is required.

7.3 SSI Communication Timing

Communication via SSI requires slave timeout (t_{out}) be met before additional clock signals may be sent. If t_{out} is not met, the encoder will resend the same information and will not latch the updated position. Figure 7 and Table 7 below provide details on timing requirements while using the Model A36R with SSI.

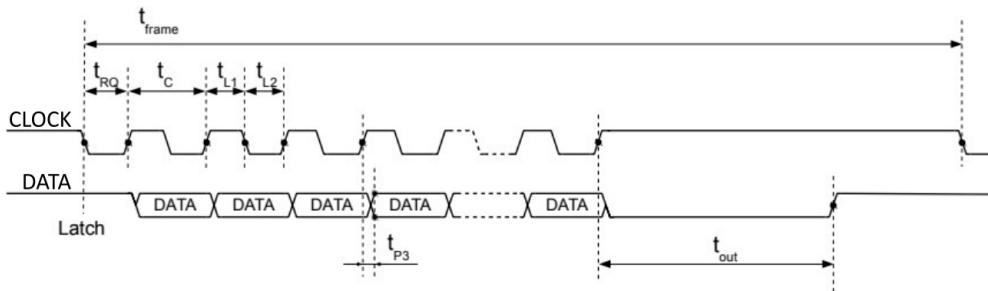

Figure 7: SSI timing diagram

Parameter	Symbol	Min	Typ	Max
Permissible Frame Repetition	t_{frame}	Allow t_{out} to elapse	--	Indefinite
REQ Signal Low Level Duration	t_{RQ}	50 ns	--	--
Permissible Clock Period	t_C	200 ns	--	--
Clock Signal High Level Duration	t_{L1}	25 ns	-	t_{out}
Clock Signal Low Level Duration	t_{L2}	25 ns	--	t_{out}
Propagation Delay	t_{p3}	--	--	132 ns*
Slave Timeout	t_{out}	16 μ s	20 μ s	24 μ s

*May increase with long cable lengths.

Table 7: SSI timing and performance characteristics

7.4 Cable Length vs. Frequency

The maximum clock frequency supplied by the master is limited by cable length.

Cable Length	Max Clock Frequency
< 1 m (3.2 ft)	5 MHz
< 35 m (115 ft)	1.7 MHz
< 60 m (197 ft)	1.0 MHz
<150 m (492 ft)	500 kHz
< 240 m (787 ft)	333 kHz
> 240 m	Not advised. Contact EPC if required.

Note: This assumes shielded twisted pair cable and proper termination are used. Lower clock frequency may be required at extreme cable lengths. Although these clock frequencies are possible, limiting frequency for SSI is advised for best performance.

Table 8: Cable length vs. max clock frequency (SSI)

An additional consideration with long cable lengths is voltage drop. Be advised that the minimum specified voltage at +VDC for this encoder must be met at the encoder. Long cable lengths equate to more voltage dropped on the cable and must be considered.

8. BiSS C Protocol

8.1 Overview

BiSS C is an open-source digital interface for sensors and actuators. BiSS is hardware compatible with the industrial standard SSI (Serial Synchronous Interface), but offers additional feature and options:

- Two unidirectional lines
- Cyclic at high speed (up to 10MHz possible using RS422)
- Line delay compensation for high-speed data transfer
- Request processing times for data generation at slaves
- Error checking: CRC, errors, warnings

Model A36R encoders with BiSS C communication are always slave devices. The fieldbus device (i.e., controller, counter) is always the master device, supplying a clock signal to which the encoder responds synchronously. This uses the same point-to-point configuration as SSI with two sets of differential signals: Clock and Data.

BiSS C uses Control Data (CD) bits in both the master data stream, Control Data Master (CDM), and the slave data stream, Control Data Slave (CDS). These bits permit the reading from and writing to slave registers and the sending of commands to slave devices one bit at a time across multiple data packets.

BiSS C can be implemented via user hardware according to the documentation provided by iC Haus at: biss-interface.com. iC Haus offers various hardware solutions to facilitate BiSS C integration:

- iC-MB4 (BiSS Master Interface IC)
- iC-MB5U (BiSS-to-USB Adaptor)

Additional information regarding the BiSS C protocol can be found at the BiSS Interface website: biss-interface.com

8.2 BiSS C Packet Structure

The data frame for Model A36R encoders with BiSS C protocol is shown in Figure 8 below.

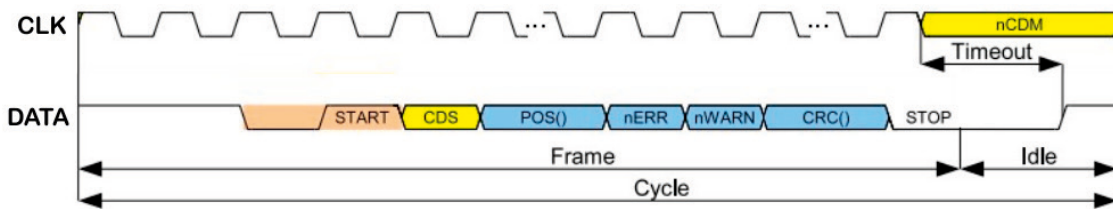

Figure 8: BiSS data exchange

The data frame includes a start bit, Control Data Slave (CDS), and Single Cycle Data (SCD). The SCD is the portion in blue in Figure 8 and includes the multi-turn position data (right-aligned), single-turn position data (left-aligned), low-active error bit nERR, low-active warning bit nWARN, and a 6-bit CRC.

If the encoder was configured with no multi-turn bits, only single-turn position data will be sent.

nERR and nWARN can be monitored to provide indication of encoder errors and warnings respectively. See Section 6.2 for details. Battery early warning and battery error will trigger these bits as well for encoders configured with the low power backup (XXL) option.

The 6-bit CRC can be used to provide error checking to the critical encoder position data. Further details on CRC can be found in Section 9. A 16-bit CRC is available upon special request. Please contact EPC if this option is required.

An optional 6-bit life cycle counter is also available upon special request. Please contact EPC if this option is required.

8.3 BiSS C Communication Timing

The encoder data is latched on the first rising clock edge. The encoder then delays its start bit and subsequent data transmission for time (t_{busy}). After all data is transmitted, the encoder requires the timeout (t_{out}) be met before additional clock pulses are sent to initiate the next frame. See Figure 9 and Table 9 below for timing details.

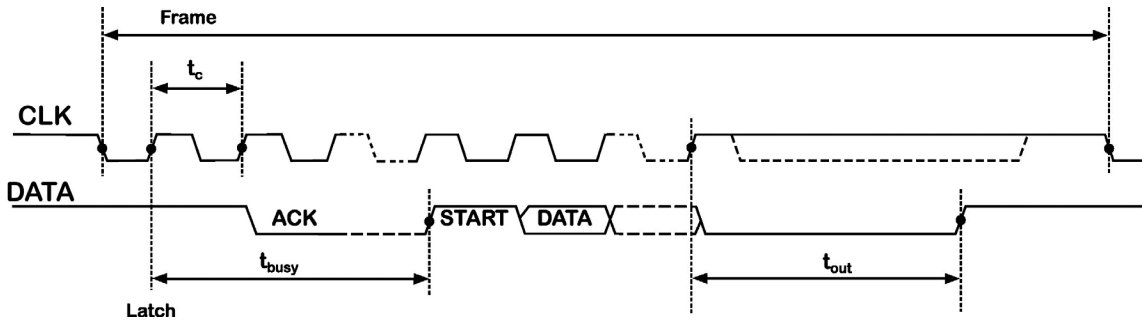

Figure 9: BiSS timing diagram

Parameter	Symbol	Description
Permissible Clock Period	t_c	100 ns min
Permissible Clock Frequency	$1 / t_c$	10 MHz
Processing Time with Start Bit Delay	t_{busy}	$5 \times t_c$ max
Adaptive Timeout at DATA Line	t_{out}	Min = 0.075 μ s Typ = $t_{init} + 0.2 \mu$ s * Max = 24 μ s

* t_{init} measured as first 1.5 x T(CLCK) for each frame.

Table 9: BiSS timing and performance characteristics

8.4 Cable Length vs. Frequency

The maximum clock frequency supplied by the master is limited by cable length.

Cable Length	Max Clock Frequency
< 150 m (492 ft)	10 MHz
> 150 m	5 MHz

Note: This assumes shielded twisted pair cable and proper termination are used. Lower clock frequency may be required at extreme cable lengths.

Table 10: Cable length vs. max clock frequency (BiSS C)

8.5 A36R BiSS Register Mapping

Model A36R encoders with BiSS C communication offer user-accessible memory locations. These include items such as electronic datasheet (EDS), an empty bank for customer data storage (i.e. motor nameplate data, customer serialization and part numbering, etc), and device information.

Note that memory is only accessible using BiSS C, as SSI does not facilitate bidirectional communication. Please refer to the following subsections for details regarding all available memory.

8.5.1 A36R General Memory Map

Bank	Address	Data Type	Description	RPL	Comments
0x24-0x27	--	--	Factory Use	RO	
0x28	--	--	BiSS EDS – Common Part	RO	See Table 12 for values
0x29	--	--	BiSS EDS – BP3: Standard Encoder Profile	RO	See Table 13 for values
0x2A	--	--	EDS Future Use	RO	
0x2B	--	--	EDS Future Use	RO	
0x2C-0x3F	--	--	User Memory Location	R/W	20 pages x 64 = 1280 bytes
0x44	--	--	Read Register	RO	Diagnostic and monitoring. See Section 8.5.4 for details.
0x45	--	--	Write Register	R/W	Configuration and commands. See Section 8.5.4 for details.
Direct Access	0x40		Bank Select	R/W	Select desired EEPROM memory bank. Not required for Direct Access memory locations.
	0x41		EDS Bank	RO	Gives location of EDS bank
	0x42		BiSS Profile ID 1	RO	0x62 (BP3 v1, Protocol rev C)
	0x43		BiSS Profile ID 2	RO	As configured (ST + MT + err/warn)
	0x44-0x47		Encoder Serial Number	RO	
	0x4E-0x4F	S16	Temperature	RO	= Value / 10° C
	0x78	U8	Device ID 5	RO	
	0x79	U8	Device ID 4	RO	
	0x7A	U8	Device ID 3	RO	
	0x7B	U8	Device ID 2	RO	
	0x7C	U8	Device ID 1	RO	
	0x7D	U8	Device ID 0	RO	
	0x7E	U8	Manufacturer ID 1	RO	0x65 (p)
0x7F	U8	Manufacturer ID 0	RO	0x70 (e)	

Table 11: BiSS general memory map

8.5.2 BiSS EDS – Common Part

The BiSS EDS – Common Part contains general device information. This is stored inside the device at bank 0x28. Details can be found in Table 12 below.

Address	Symbol	Description	Group	Data Format	Unit	Value	Comments
0x00	EDS_VER	EDS version	Orga	U8	--	1	
0x01	EDS_LEN	EDS length	Orga	U8	Banks	2	Common + BP3
0x02	USR_STA	Bank address USER start (bank selection in address 64,255=not available)	Orga	U8	--	44	0x2C hex
0x03	USR_END	Bank address USER end (bank selection address 64)	Orga	U8	--	63	0x3F hex
0x04	TMA	Minimum permitted clock period on MA	Timing	U8	1 ns	100	
0x05	TO_MIN	Minimum BiSS timeout (0=adaptive)	Timing	U8	250 ns	0	Adaptive
0x06	TO_MAX	Maximum BiSS timeout (0=adaptive)	Timing	U8	250 ns	0	Adaptive
0x07	TOS_MIN	Minimum BiSS timeout_S (0=adaptive)	Timing	U8	25 ns	0	Adaptive
0x08	TOS_MAX	Maximum BiSS timeout_S (0=adaptive)	Timing	U8	25 ns	0	Adaptive
0x09	TCLK_MIN	Minimum sampling period, adaptive timeout (0=adaptive timeout not available)	Timing	U8	25 ns	50	
0x0A	TCLK_MAX	Maximum sampling period, adaptive timeout (0=adaptive timeout not available)	Timing	U8	25 ns	75	
0x0B	TCYC	Minimum cycle time (0=no limitation)	Timing	U8	250 ns	0	
0x0C	TBUSY_S	Maximum processing time SCD	Timing	U8	250 ns	0	
0x0D	BUSY_S	Maximum processing time SCD in clocks	Timing	U8	TMA	5	

Address	Symbol	Description	Group	Data Format	Unit	Value	Comments
0x0E-0x0F	PON_DLY	Maximum “power on delay” until control communication is available	Timing	U16*	1 ms	50	
0x10	DC_NUM	Number of data channels in this device (number of words)	SCD	U8	--	1	
0x11	SL_NUM	Area of validity for this EDS (number of slave addresses)	SCD	U8	--	1	
0x12	SL_OFF	Memory location for this EDS (slave ID within this device)	SCD	U8	--	0	
0x13	--	Reserved	--	--	--	0	
0x14	BANK1	Bank address for content description data channel 1 (profile EDS)	SCD	U8	--	0x29	
0x15	DLEN1	Data length for channel 1	SCD	U8	bit	To match ordered configuration	(DL + err and warn)
0x16	FORMAT1	Data format data channel 1	SCD	U8	bit	bit	
0x17	CPOLY1	CRC polynome (8:1) for data channel 1	SCD	U8	--	0x21	
0x18-0x33	n/a	Unused	--	--	--	--	
0x34	BC_OFF	Bus coupler control location for this device (slave ID within this device)	SCD	U8	--	0	
0x35-0x3E	--	Reserved	Prot	U8	--	0	
0x3F	CHKSUM	Checksum (additional bytes within this bank)	Orga	U8	--	xx	

Table 12: BiSS EDS – Common Part

8.5.3 BiSS EDS – BP3: BiSS Standard Encoder Profile

The BiSS EDS – BP3: BiSS Standard Encoder Profile provides additional device level information. The data here is geared towards encoder configuration and BiSS C communication. This is stored inside the device at bank 0x29. Details can be found in Table 13 below.

Address	Symbol	Description	Group	Data Format	Unit	Value	Comments
0x00	BP_VER	BiSS Profile 3 Version	Orga	U8	--	1	
0x01	BP_LEN	Length of this profile	Orga	U8	Banks	1	
0x02	BP_ID	Profile identification BP3 (content also available in address 0x42 and 0x43)	Orga	U8	--	0x62	
0x03				U8	--	=DL=1...57	
0x04	FB1	Feedback bit 1; low active error status nE	Orga	U8	Table B	1	Low active error nE
0x05	FB2	Feedback bit 2; low active error status nW	Orga	U8	Table B	2	Low active error nW
0x06	PON_PDL	Maximum "power on delay" until position data are available	Timing	U8	ms	50	
0x07	--	Reserved	--	--	--	--	
0x08	EN_TYP	Encoder type	Orga	U8	--	0	Rotary encoders
0x09	POS_NUM	Position value	Safety	U8	--	1	1 position
0x0A	MT_LEN	Data length, MULTITURN	Orga	U8	Bit	To match ordered configuration	Multi-turn bit resolution
0x0B	MT_FMT	Data format, MUTLITURN	Meas	U8	--	0	Right-aligned
0x0C	CO_LEN	Data length, COARSE	Orga	U8	Bit	0	n/a
0x0D	CO_FMT	Data format, COARSE	Meas	U8	Table F	0	n/a
0x0E	FI_LEN	Data length, FINE	Orga	U8	Bit	To match ordered configuration	Single turn bit resolution
0x0F	FI_FMT	Data format, FINE	Meas	U8	--	1	Left-aligned
0x10-0x13	MT_CNT	Number of distinguishable revolutions/period	Meas	U32*	Count	To match ordered configuration	2^{MT_BITS}
0x14-0x17	SIP_CNT	Number of signal periods per revolution/length of signal period	Meas	U32*	PPR (rotary) nm (linear)	1	

Address	Symbol	Description	Group	Data Format	Unit	Value	Comments
0x18-0x1B	SIP_RES	Resolution factor per signal period (LSB of the interpolation)	Meas	U32*	LSB	To match ordered configuration	2^{ST_BITS}
0x1C-0x1F	CPOLY	CRC polynomial (32:1)**	Orga	U32*	--	0x21	
0x20-0x23	CSTART	CRC start value***	Orga	U32*	--	0	
0x24-0x25	ABS_ACU	Absolute accuracy	Meas	U16*	LSB/2 μm	0	
0x26-0x27	REL_ACU	Repeat accuracy	Meas	U16*	LSB/2	0	
0x28-0x29	SPD_ACU	Angular speed/speed depending on accuracy	Meas	U16*	LSB/2	0	
0x2A-0x2B	HYST	Hysteresis	Meas	U16*	LSB/2	0	
0x2C-0x2D	SPD_MAX	Maximum revolution speed/maximum speed	Mech	U16*	1/min m/min	8000	
0x2E-0x2F	ACC_MAX	Maximum angular acceleration/maximum acceleration	Mech	U16*	1/min ² m/min ²	360000	
0x30-0x31	TMP_MIN	Minimum operating temperature	Mech	U16*	K	233	
0x32-0x33	TMP_MAX	Maximum operating temperature	Mech	U16*	K	393	
0x34-0x35	VLT_MIN	Minimum operating voltage	Elec	U16*	mV	4750	
0x36-0x37	VLT_MAX	Maximum operating voltage	Elec	U16*	mV	To match ordered configuration	
0x38-0x39	CUR_MAX	Maximum current consumption	Elec	U16*	mA	100	
0x3A-0x3E	--	Reserved	--	--	--	--	
0x3F	CHKSUM	Checksum (sum of bytes in 0x00-0x3E)	Orga	U8	--	xx	

* The U16/U32 values are saved as Big Endian, i.e., with the highest-value byte at the lowest value address

** The CRC is located 32:1 as least significant bit is on active CRC checking always 1

*** The CRC start value range is limited by the BiSS Safety Profile Definition

Table 13: BiSS EDS – BP3: BiSS standard encoder profile

8.5.4 Read and Write Registers

Two register spaces are available for status reads and device configuration. These register spaces are described in Table 14 and Table 15 below.

Read Register Space, Bank 0x44		
Address	Data Type	Description
0x00	U8	FW version minor
0x01	U8	FW version major
0x02	U16	Reserved
0x04	U8	Command status; provides status of the Command Register. See Table 17.
0x05	S16	Shaft speed (RPM); provides directional shaft speed with MEASURE command. See Section 8.6.2 for MEASURE command details.
0x07	U32	Single turn count; provides single turn count with MEASURE command. See Section 8.6.2 for MEASURE command details.
0x0B	U32	Multi-turn count; provides single turn count with MEASURE command. See Section 8.6.2 for MEASURE command details.
0x0F	U8	Reserved
0x10	U8	Error register; displays current error bits with DIAG command. See Section 6.2 for error bit details. See Section 8.6.3 for DIAG command details.
0x11	U8	Warning register; displays current warning bits with DIAG command. See Section 6.2 for warning bit details. See Section 8.6.3 for DIAG command details.

Table 14: Model A36R read register description

Write/Configuration Register Space, Bank 0x45		
Address	Data Type	Description
0x00	U8	Command Register; accepts various commands. See Section 8.6
0x01	U32	ST Preset; use PRESET command to apply. See Section 8.6.1
0x05	U32	MT Preset; use PRESET command to apply. See Section 8.6.1
0x09	S16	Temperature warning high limit; use TEMP_LIMIT_SET command to apply. This is internal sensor junction temp. See Section 8.6.4 Units are S16 with Temp Limit = value / 10 ° C.
0x0B	S16	Temperature warning low limit; use TEMP_LIMIT_SET command to apply. This is internal sensor junction temp. See Section 8.6.4 Units are S16 with Temp Limit = value / 10 ° C.

Table 15: Model A36R write/configuration register description

8.6 BiSS Commands

The Model A36R offers a variety of commands useful for initial setup and troubleshooting. The commands in Table 16 below are written to the Command Register (Bank 0x45, Address 0x00).

Commands: Write to Bank 0x45, Address 0x00 to use		
Value	Command Name	Description
0x00	REBOOT	Soft reset of the internal position sensor.
0x01	SCLR	Clears all error/warning bits. See Section 6.2 for error/warning monitoring. Can also be sent manually, see Section 6.1. NOTE: This will likely drop BiSS communication and require reconnection.
0x02	SYNC	Re-synchronize primary and backup turns counting devices (XXL option only).
0x03	ZERO	Sets the current position as ST/MT = 0
0x04	PRESET	Sets the current position to the ST/MT preset values stored in the write/config register. See Section 8.6.1 for more details.
0x05	MEASURE	Read current ST/MT position and RPM to read register. See Section 8.6.2 for more details.
0x06	DIAG	Read current ST/MT position and RPM to read register. See Section 8.6.2 for more details.
0x07	TEMP_LIMIT_SET	Set temperature alarm high/low limits as configured in write/config register. See 8.6.4 for more details.

Table 16: Model A36R BiSS commands

Upon writing these commands to the command register, the command status register will become busy until the command has been completed. The register must return to idle before another command can be sent. Table 17 below details the command status register return codes.

Command Status Register (Bank 0x44, Address 0x04, Data Type U8)	
Return Code	Status Description
0x00	Command Register Idle
0x01	Command Status Busy

Table 17: Command status register return codes



Always check that the Command Status register is in the idle state (0x00) before attempting to send a command.

8.6.1 PRESET Command

The PRESET command sets the current shaft position to a ST/MT value specified by the user. The desired ST/MT values to be configured are set in the ST Preset and MT Preset registers respectively. These are located in Bank 0x45 at addresses 0x01 (ST) and 0x05 (MT). See Table 15.

8.6.2 MEASURE Command

The MEASURE command reads the current ST and MT position, as well as the current calculated RPM. Once read, these values will be readable from Bank 0x44 at addresses 0x07 (ST count), 0x0B (MT count), and 0x05 (RPM). See Table 14.

8.6.3 DIAG Command

The DIAG command reads all error and warning bits. Once read, the status of these bits will be readable from Bank 0x44 at addresses 0x10 (error bits) and 0x11 (warning bits). See Table 14.

Description of all error and warning bits can be found in Section 6.2.

8.6.4 TEMP_LIMIT_SET Command

The TEMP_LIMIT_SET command sets the high/low temperature warning thresholds into the internal temperature sensor. The values to be set can be user-configured via Bank 0x45 at addresses 0x09 (high limit) and 0x0B (low limit).

Note that these limit values are internal sensor junction temperatures. These will differ from ambient temperature and may need to be adjusted experimentally to correlate with the application requirements.

Real-time temperature can be read via direct access (no bank select needed) at address 0x4E-0x4F. See Table 11.

9. CRC Details

Model A36R encoders include a CRC in the data frame for both SSI and BiSS C protocol options. The CRC can be used to verify data integrity. The CRC is the same for both communication protocol options and details can be found below.

CRC start value	=	0x00
CRC polynomial	=	0x43
CRC results length	=	6 bits

Different CRC lengths and starting values may be possible. Contact EPC details if this is a requirement for your application.

More details on CRC and calculation examples can be found on the BiSS Interface website at: biss-interface.com

10. Model A36R Datasheet

For detailed specifications, wiring table, and cable configurations, see the product datasheet on the next page or at encoder.com.

MODEL A36R - ABSOLUTE THRU-BORE / BLIND HOLLOW BORE ENCODER

MODEL A36R SPECIFICATIONS

Electrical

Input Voltage.....	4.75-24 VDC max for temp up to 85° C 4.75-20 VDC max for temp up to 100° C 4.75-5.5 VDC max for temp > 100° C Input Current ≤ 100 mA at No Load
Power Consumption.....	2.0 W max
Electrical Protection.....	Transient Overvoltage, Reverse, and Short Circuit
Code.....	Gray or Binary for SSI; Binary for BiSS C
Resolution (Single).....	.01 to 22 bit
Resolution (Multi).....	.01 to 24 bit, and battery backed option
Position Sensor Update.....	≤ 5 μs
Sensing Method.....	Optical
Internal Temp. Sensor (TJ).....	-40° to 140° C (not accessible with SSI protocol)
NV Memory.....	4096 Bytes for customer motor name plate data, etc.
Accuracy.....	Better than 45 ArcSec from True Position
Repeatability.....	20 ArcSec between repeat moves to any position
CE/EMC.....	Immunity tested per EN 61000-6-2:2019 Emissions tested per EN 61000-6-4:2019

Battery (XXL only)

Battery supply voltage (at V _{BAT+}) ¹	3.05 - 5.5 V
Battery supply current, no +VDC.....	7 μA with no shaft movement >7 μA with shaft movement ²
Battery supply current, with +VDC.....	<10 nA
Recommended min battery capacity.....	800 mAh

¹ 3.6V recommended. Voltage at V_{BAT+} ≤ 3.15 V will trigger a battery warning, ≤3.05 V will trigger a battery error and cause the encoder to lose MT count. Battery monitoring only active while suitable +VDC supply is present.

² Current draw with shaft movement dependent on shaft speed. See manual for details.

SSI Protocol

SSI stands for Synchronous Serial Interface. SSI is an RS 422 serial interface widely used with absolute encoders and controllers in a master slave configuration. SSI encoders offer an all-digital, unidirectional point-to-point connection. For more detailed information see the A36R Technical Reference Manual at encoder.com.

BiSS C Interface

BiSS C stands for Bidirectional Serial Synchronous, Continuous mode interface. BiSS C is similar to SSI and can be used uni-directionally like SSI; however, BiSS C also supports bidirectional communication and operates at speeds up to 10 Mbps/sec. BiSS C can address internal registers in the encoder that can be read and written to by the master, allowing configuration and monitoring of the encoder not possible with uni-directional communication. Reads and writes can be performed by the master on demand, without interfering with real-time operation. This communication protocol is used by industrial automation devices and a common high speed reliable digital solution between absolute encoders and motion controllers. For more detailed information see the A36R Technical Reference Manual at encoder.com

Mechanical

Max Shaft Speed.....	8,000 RPM; higher speeds may be achievable, contact Customer Service.
User Shaft Radial Runout.....	0.13 mm [0.005"]
User Shaft Axial Endplay.....	0.76 mm [0.030"]
Starting Torque.....	IP50 Blind Hollow Bore: 0.0007 N-m [0.1 oz-in] IP50 Thru-Bore: 0.0021 N-m [0.3 oz-in] IP64 Blind Hollow Bore: 0.0014 N-m [0.2 oz-in]
Weight.....	50 g (1.8 oz typical)
Shaft Type.....	Up to 10 mm thru-bore or blind hollow bore
Moment of Inertia.....	4.2 gm-cm ² (5.9 x 10 ⁻⁵ oz-in-cm ²)

Environmental

Operating Temp.....	-40° to 120° C (see Input Voltage for limitations)
Storage Temp.....	-20° to 85° C
Humidity.....	98% RH non-condensing
Vibration.....	20 g, 10 to 2000 Hz (according to IEC 60068-2-6)
Shock.....	100 g @ 11 ms duration (according to MIL-STD-202G 213B)
Sealing.....	IP50 (DIN EN 60529); IP64 optional

MODEL A36R 1.812" (46 MM) SLOTTED FLEX MOUNT (SF)

Shown with RMH connector

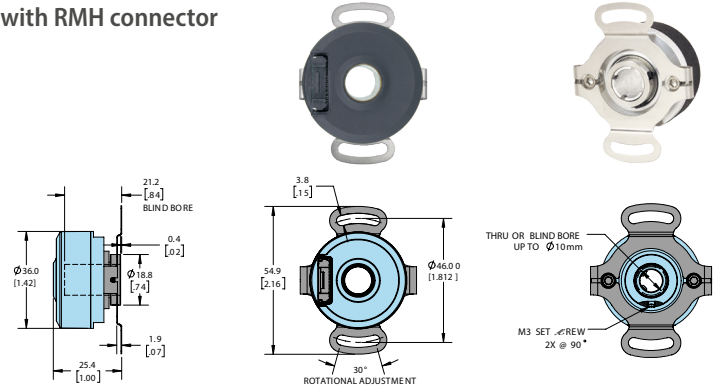

MODEL A36R 1.812" (46 MM) TWO-HOLE FLEX MOUNT (SA)

Shown with Fixed Cable

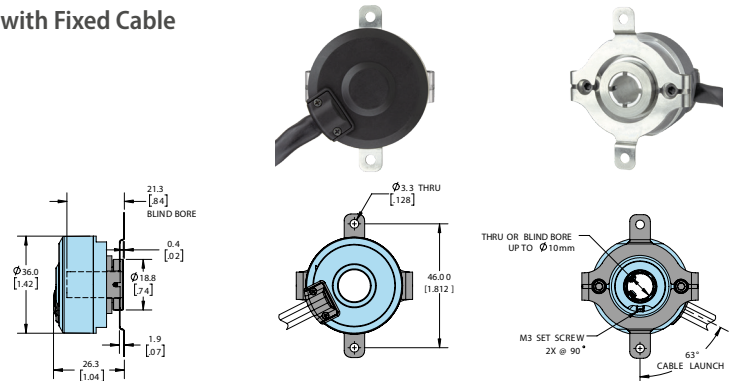

MODEL A36R SMALL DIAMETER SLOTTED FLEX MOUNTS

SB Mount

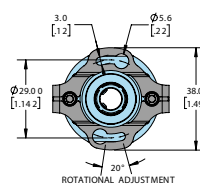

SC Mount

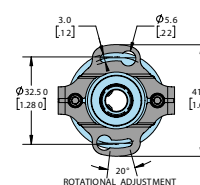

SD Mount

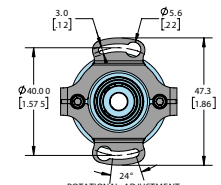

Encoder length and diameter are the same as SF and SA mounts detailed above.

Primary dimensions are in mm, secondary dimensions SI units [inches] in brackets for reference only. All dimensions have a tolerance of ±0.25mm unless otherwise specified.

MOUNTING AND INSTALLATION KIT

*Order appropriate no charge Mounting and Installation Kit for SB, SC, or SD option. Each kit contains 10 screws for mounting 5 encoders.

- 176150-01 Installation Kit, 4-40 buttonhead screws with 0.062" shortened hex wrench
- 176149-01 Installation Kit, M2.5 buttonhead screws with 1.5 mm shortened hex wrench

MODEL A36R - ABSOLUTE THRU-BORE / BLIND HOLLOW BORE ENCODER

WIRING TABLES

Single turn or multi-turn N (Normal Power)

Header Pin #	Function	Wire Color
1	NC	--
2	NC	--
3	+VDC	White
4	Com	Violet
5	Position Preset	Brown
6	Shield**	Bare
7	Data -	Orange
8	Data +	Blue
9	Clock -	Yellow
10	Clock +	Green

Multi-turn L (Low Power)

Header Pin #	Function	Wire Color
1	VBAT +	Red [†]
2	VBAT -*	Black [†]
3	+VDC	White
4	Com*	Violet
5	Position Preset	Brown
6	Shield**	Bare
7	Data -	Orange
8	Data +	Blue
9	Clock -	Yellow
10	Clock +	Green

*Pins are electrically connected within encoder.

[†]For Single turn and Normal power multi-turn encoders, the external power wires (red and black) are not used.

**CE Option: Cable shield (bare wire) is connected to internal case.

CONNECTORS

Radial Mount Header (RMH option, shown)

Molex part # 5055671031

Mating Connector

Molex part # 5055651001

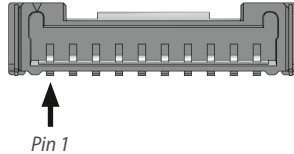

CABLE OPTIONS

Power-ready cable

For multi-turn low power (L) option, user supplies external power.

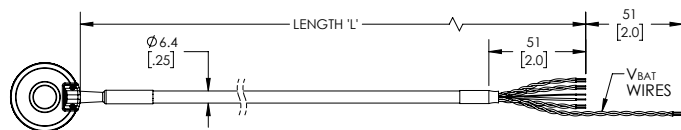

Embedded battery cable

For multi-turn low power (L) option with Embedded Battery Cable option (EB), battery supplies external power.

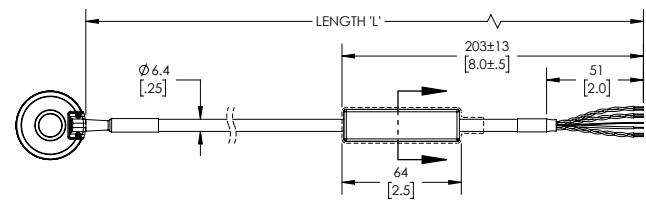

Battery notes:

1. The battery section of the cable is rigid and non-flexible.
2. Battery is located close to the customer end of the cable, and is housed in a protective enclosure secured directly to the cable.
3. Maximum rated battery operating temperature is 85° C.
4. Minimum total cable length for EB option is 30 cm (1 foot).

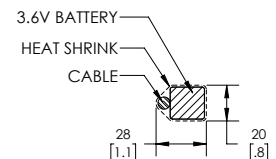

EPC RESERVES THE RIGHT TO UPDATE, REVISE AND AMEND ALL SOFTWARE AND TECHNICAL DATA OR CONTENT AT ANY TIME. EPC SHALL HAVE NO LIABILITY OF ANY KIND OR NATURE FOR ANY TECHNICAL ERRORS OR OMISSIONS IN ANY SOFTWARE OR TECHNICAL DATA. See encoder.com for more information.